

Pos.	DN	Art.no.
1	15-20	187187

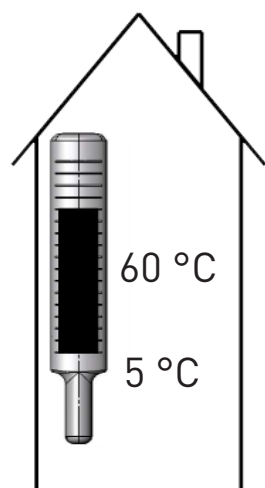

Amb. temp.

LK 830 ThermoMix[®] B

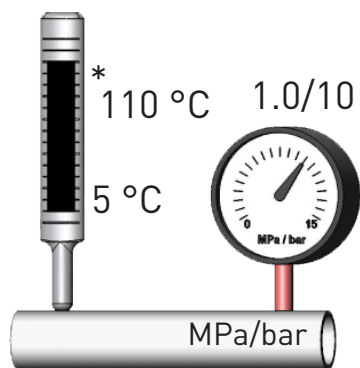
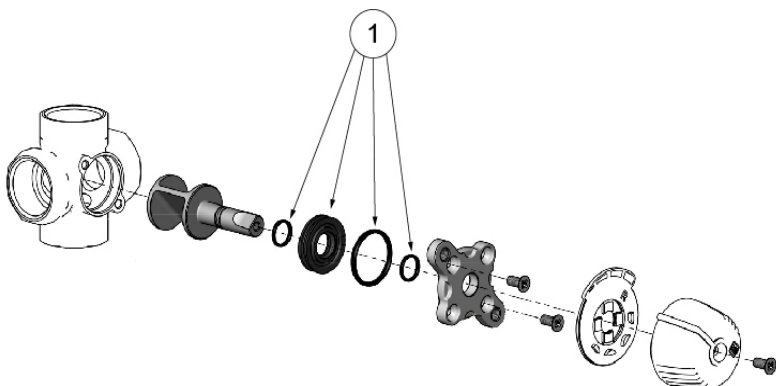

Mixing Valve | Mischer | Vanne mélangeuse |
Valvola miscelatrice meccanica | Sekoitus-venttiili
| Shuntventil



LK ARMATUR AB
Garnisonsgatan 49
SE-254 66 Helsingborg
Info@lkarmatur.com
lkarmatur.com

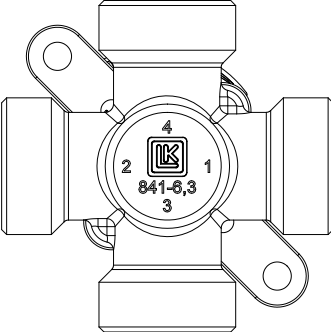
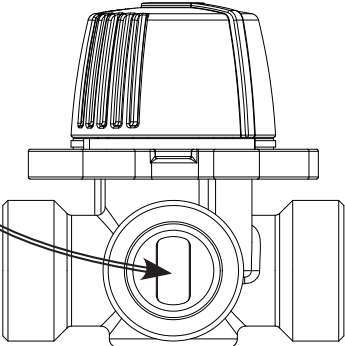
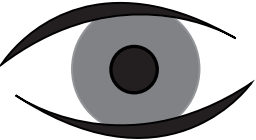

B

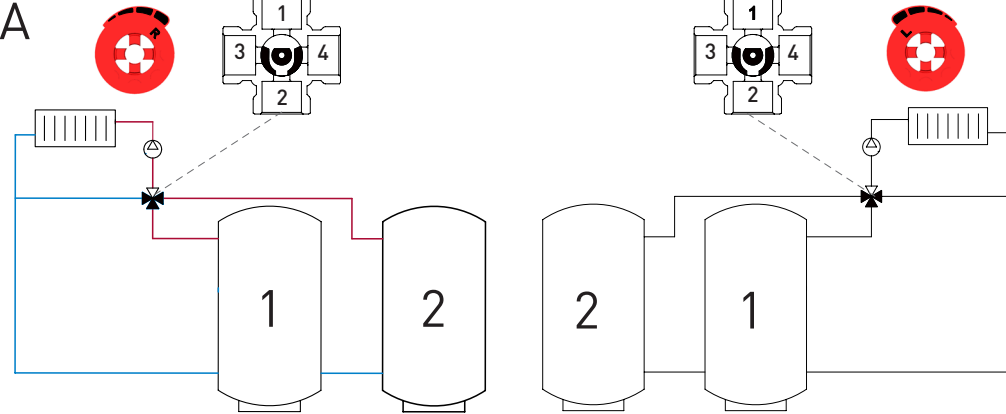
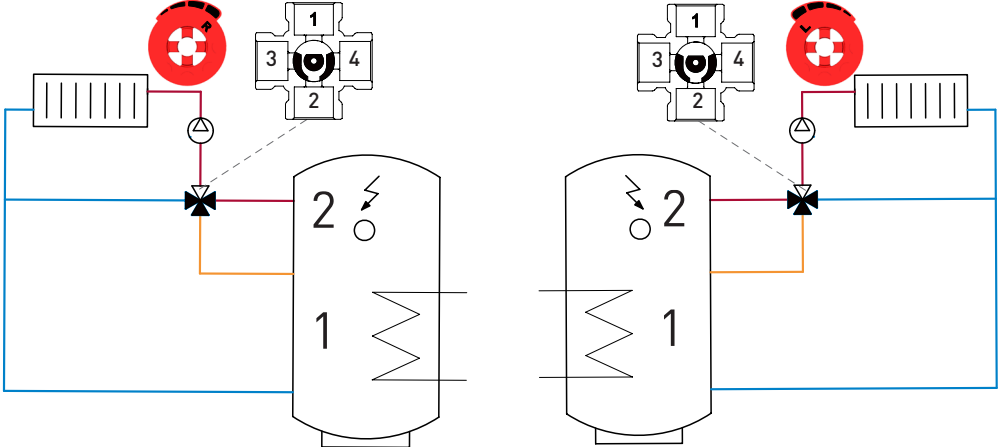

C

