



LK HydronicGroup C/C 125 866



TECHNICAL DATA

Voltage	230 VAC 50/60 Hz
Power consumption	10-75 W depending on pump speed
Working temperature	Min. 5 °C/Max. 100 °C
Ambient temp.	Min. 5 °C/Max. 58 °C
Max. working pressure	1,0 MPa (10 bar)
Media	Water - Glycol mixture max. 50%
Thread standard	Rp - female thread, G - male thread
Circulating pump	Wilo PARA 25-180/6-43/SC-12 Wilo PARA 25-180/8-75/SC-12
Material, valve body	Brass EN 12165 CW617N
Material, insulation	Expanded Polypropylene EPP

LK HydronicGroup 866 is a pump group with a four way mixing valve, LK 841 ThermoMix®.

The pumpgroup is designed for heating systems where a high return temperature is required to prevent corrosion and thus extend the life length of the heat source.

LK HydronicGroup comprises a highly efficient circulation pump, insulation, wall mounting bracket and two ball valves with thermometer, of which the ball valve on the return side has an integrated check valve.

TECHNISCHE DATEN

Nennspannung	230 VAC 50/60 Hz
Leistungsaufnahme	10-75 W abhängig von Pumpendrehzahl
Arbeitstemperatur	Min. 5 °C/Max. 100 °C
Umgebungstemperatur	Min. 5 °C/Max. 58 °C
Max. Arbeitsdruck	1,0 MPa (10 bar)
Flüssigkeit	Wasser - Glykol max. 50%
Gewindenorm	Rp - Innengewinde, G - Aussengewinde
Umwälzpumpe	Wilo PARA 25-180/6-43/SC-12 Wilo PARA 25-180/8-75/SC-12
Material, Gehäuse	Messing EN 12165 CW617N
Material, Isolierung	Expandiertes Polypropylen EPP

Die LK HydronicGroup 866 ist eine Pumpengruppe mit einem 4-Wege Mischventil, LK 841 ThermoMix®.

Die Pumpengruppe ist geeignet für Heizanlagen, in denen eine hohe Rücklauftemperatur erwünscht ist, um Korrosion zu vermeiden und damit die Lebensdauer der Heizquelle zu verlängern.

Die LK HydronicGroup besteht unter anderem aus einer hocheffektiven Zirkulationspumpe, Isolierung, Konsole für die Wandmontage sowie zwei Kugelventilen mit Thermometer. Das Kugelventil für die Rücklaufseite hat ein integriertes Rückschlagventil.

DONNÉES TECHNIQUES

Tension nominale	230 VAC 50/60 Hz
Puissance maxi chaudière	10-75 W suivant position circulateur
Température de service	Min. 5 °C/Max. 100 °C
Température d'ambiance	Min. 5 °C/Max. 58 °C
Pression de service max.	1,0 MPa (10 bar)
Fluide	Eau - Glycol max. 50%
Filetage standard	Rp - filetage femelle, G - filetage mâle
Circulateur	Wilo PARA 25-180/6-43/SC-12 Wilo PARA 25-180/8-75/SC-12
Matériau, corps de vanne	Laiton EN 12165 CW617N
Matériau, isolation	Polypropylène Expandé EPP

LK HydronicGroup 866 est un groupe de pompes avec une vanne mélangeuse à quatre voies, LK 841 ThermoMix®.

Le groupe de pompe est destiné pour les systèmes de chauffage qui convient particulièrement lorsqu'une température de retour plus élevée est souhaitée afin d'éviter la corrosion et rallonger la longévité de la chaudière.

LK HydronicGroup comprend entre autres une pompe de circulation très efficace, une isolation, une console pour le montage mural, et deux robinets à boisseau sphérique avec un thermomètre, dont le robinet à boisseau sphérique du côté retour dispose d'un clapet antiretour.

DATI TECNICI

Voltaggio	230 VAC 50/60 Hz
Consumo	10-75 W secondo la velocità della pompa
Temperatura di esercizio	Min. 5 °C/Max. 100 °C
Temperatura ambiente	Min. 5 °C/Max. 58 °C
Pressione massima di esercizio	1,0 MPa (10 bar)
Fluidi	Acqua. Miscela Acqua - Glicole max. 50%
Filettatura standard	Rp - filettatura femmina, G - filettatura maschio
Pompa di ricircolo	Wilo PARA 25-180/6-43/SC-12 Wilo PARA 25-180/8-75/SC-12
Materiale, corpo valvola	Ottone EN 12165 CW617N
Materialie, isolante	Polipropilene Espanso EPP

LK HydronicGroup 866 è un gruppo pompa con una valvola miscelatrice a quattro vie, LK 841 ThermoMix®.

Il gruppo pompa è destinato per impianti di riscaldamento dove si desidera una elevata temperatura dell'acqua di ritorno verso la caldaia.

LK HydronicGroup comprende, fra l'altro, la pompa di ricircolo ad alta efficienza, l'isolamento, la staffa per montaggio a parete e due valvole a sfera con termometro, con la valvola a sfera sul lato di ritorno dotata di valvola di non ritorno integrata.

TEKNILLISET TIEDOT

Jännite	230 VAC 50/60 Hz
Tehonkulutus	10-75 W pumpun nopeudesta riippuen
Käyttölämpötila	Min. 5 °C/Maks. 100 °C
Ympäristön lämpötila	Min. 5 °C/Maks. 58 °C
Maks. käyttöpain	1,0 MPa (10 bar)
Siirtoneste	Vesi - Glykolia maks. 50%
Kierrestandardi	Rp - sisäkierre, G - ulkokierre
Kiertovesipumput	Wilo PARA 25-180/6-43/SC-12 Wilo PARA 25-180/8-75/SC-12
Materiaali, venttiilipesä	Messinki EN 12165 CW617N
Materiaali, eriste	Paisutettu Polypropeeni EPP

LK HydronicGroup 866 -pumppuryhmään kuuluu nelitieshunntiventtiilin LK 841 ThermoMix®.

Pumppuryhmä on tarkoitettu lämmitysjärjestelmiin, joissa vaaditaan korkea paluulämpötila korroosion välttämiseksi ja käyttöiän pidentämiseksi.

LK HydronicGroup koostuu mm. erittäin tehokkaasta kiertopumpusta, eristyksestä, seinäasennuskonsolista ja kahdesta kuula-venttiilistä, joissa on lämpömittari. Paluupuolen kuula-venttiilissä on integroitu suuntaventtiili.

TEKNISK DATA

Spänning	230 VAC 50/60 Hz
Effektförbrukning	10-75 W beroende av pumphastighet
Arbetstemperatur	Min. 5 °C/Max. 100 °C
Omgivningstemperatur	Min. 5 °C/Max. 58 °C
Max. arbetstryck	1,0 MPa (10 bar)
Media	Vatten - Glykolinblandning max. 50%
Gängstandard	Rp - invändig gänga, G - utvändig gänga
Cirkulationspump	Wilo PARA 25-180/6-43/SC-12 Wilo PARA 25-180/8-75/SC-12
Material, venttilhus	Mässing EN 12165 CW617N
Material, isolering	Expanderad Polypropylen EPP

LK HydronicGroup 866 är en Pumpgrupp med en fyrvägs shuntventil LK 841 ThermoMix®.

Pumpgruppen är avsedd för värmesystem där en hög returtemperatur krävs för att förhindra korrosion och därmed förlänga värmekällans livslängd.

LK HydronicGroup består bland annat av högeffektiv cirkulationspump, isolering, konsol för väggmontage samt två kulventiler med termometer varav kulventil till retursidan har integrerad backventil.



LK 866 - PUMP CHARACTERISTICS

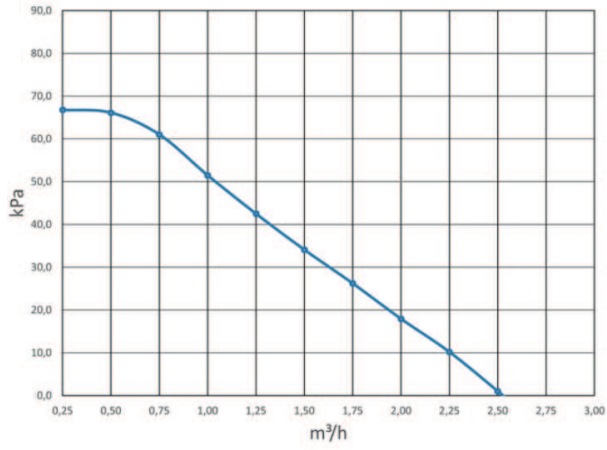

LK 866 - PUMP GROUP WITH DIRECT SUPPLY

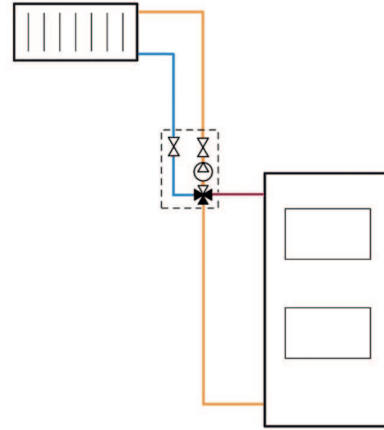

LK 866 - PUMP GROUP

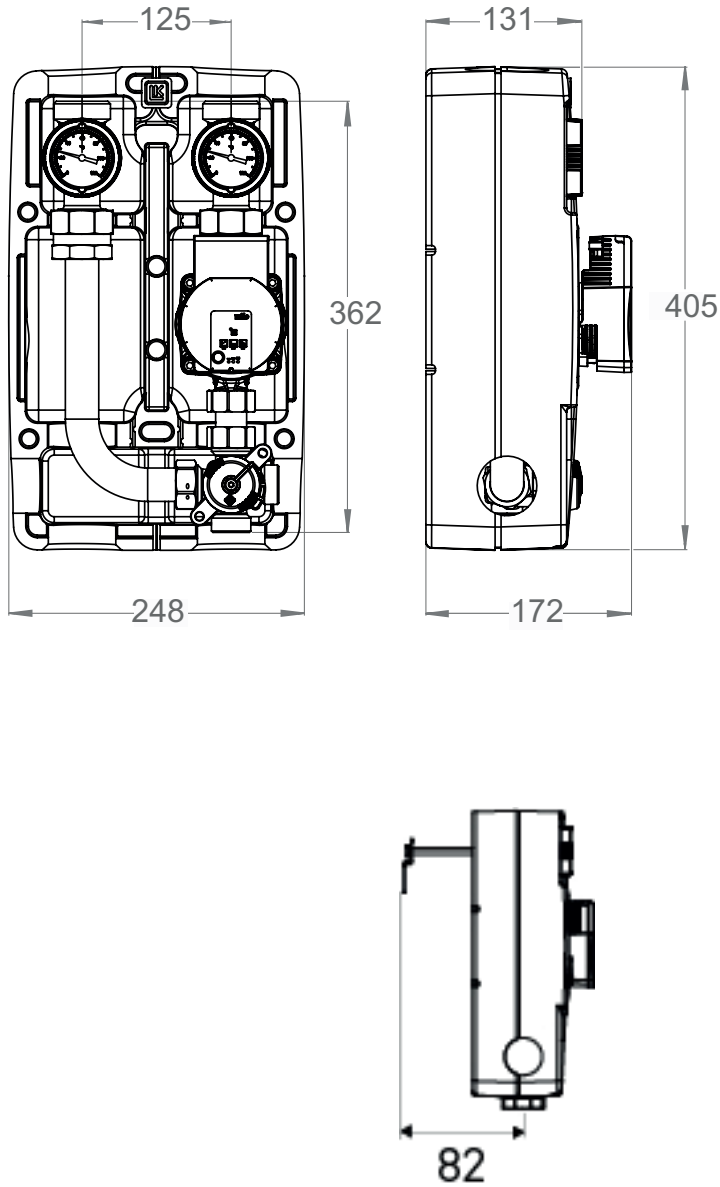

LK 866 - RIGHT

LK 866 - LEFT

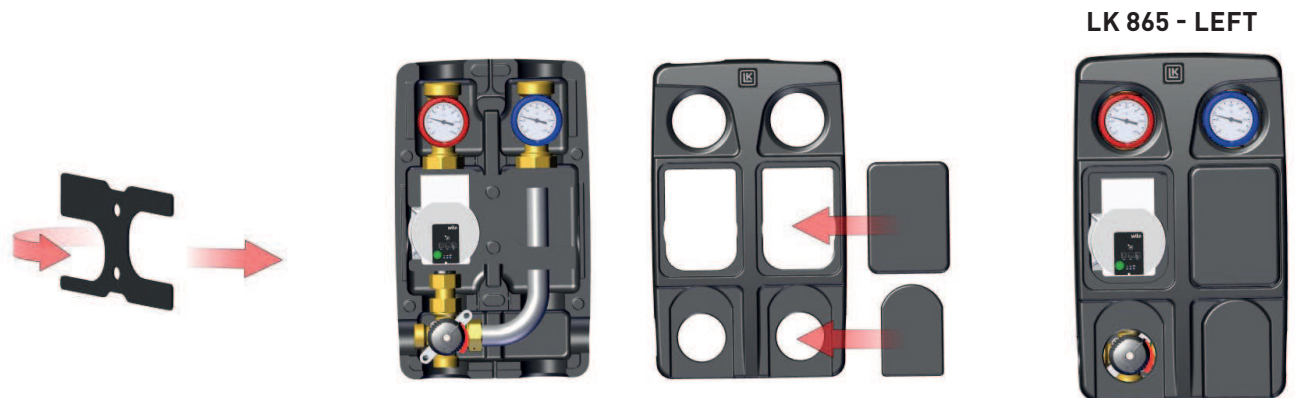
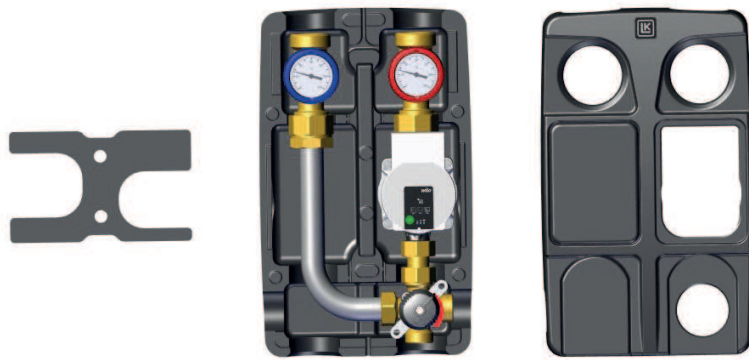
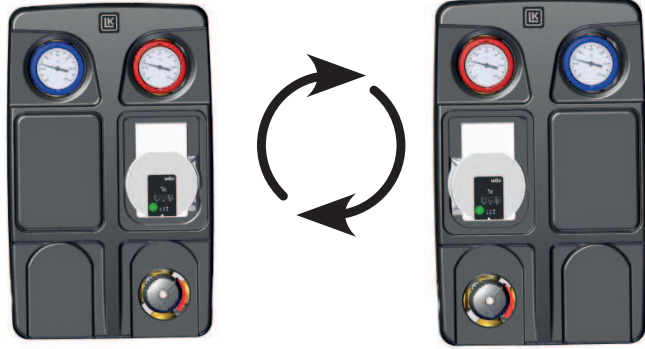

ACCESSORIES | ZUBEHÖR | ACCESSOIRES | ACCESSORI | LISÄVARUSTEET | TILLBEHÖR



Article no.	Article	Position
187203	Wilo PARA 25-180/8-75/SC-12 Circulating pump Zirkulationspumpe Circulateur Pompa di ricircolo Kiertovesipumppu Cirkulationspump	1
187322	Wilo PARA 25-180/6-43/SC-12 Circulating pump Zirkulationspumpe Circulateur Pompa di ricircolo Kiertovesipumppu Cirkulationspump	1
187323	Ballvalve, blue Kugelventil, blau Robinet à bille, bleu Valvola a sfera, blu Palloventtiili, sininen Kulventil, blå	2
187324	Ballvalve, red Kugelventil, rot Robinet à bille, rouge Valvola a sfera, rossa Palloventtiili, punainen Kulventil, röd	2
187325	Bracket Konsole Console Collettore Konsoli Konsol	3
187326	EPP Insulation EPP Isolierung EPP Isolation EPP Isolmento EPP eriste EPP Isolering	4
181949	Mixing Valve Kvs 6,3 Mischer Kvs 6,3 Vanne mélangeuse Kvs 6,3 Valvola michelatrice meccanica Kvs 6,3 Sekoitusventtiili Kvs 6,3 Shuntventil Kvs 6,3	5

Wilo-Para Quick start guide



WILO-PARA SELF CONTROL / INSTALLATION

One push-button

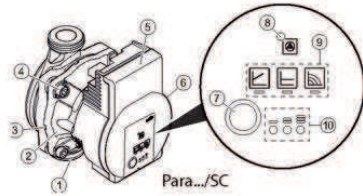

- 1 Pump housing with screwed connections
- 2 Glandless motor
- 3 Condensate drain openings (4x around circumference)
- 4 Housing screws
- 5 Control module
- 6 Rating plate
- 7 Green push button
- 8 Fault signal LED
- 9 Display for control mode ($\Delta p-v$, $\Delta p-c$, N constant)
- 10 Display for speed setting (I, II, III)

Electrical connection

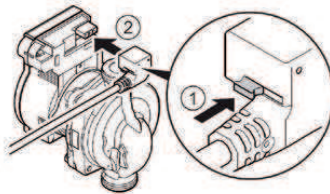

Standard factory setting

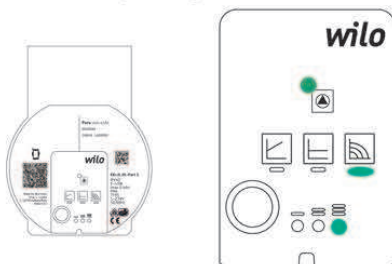

WILO-PARA SELF CONTROL / SETTING

Differential pressure variable $\Delta p-v$ (I, II, III)

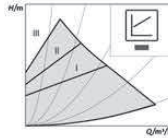

Recommended for two-pipe heating systems with radiators to reduce the flow noises at thermostatic valves.

Constant differential pressure $\Delta p-c$ (I, II, III)

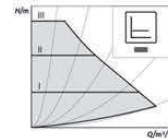

Recommended for underfloor heating or for large-sized pipes, applications without a variable pipe network curve (e.g. storage charge pumps) or single-pipe heating systems with radiators.

Constant speed (I, II, III)

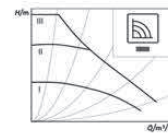

Recommended for systems with fixed system resistance requiring a constant volume flow and for replacement of AC pumps.

Push to change the pump setting

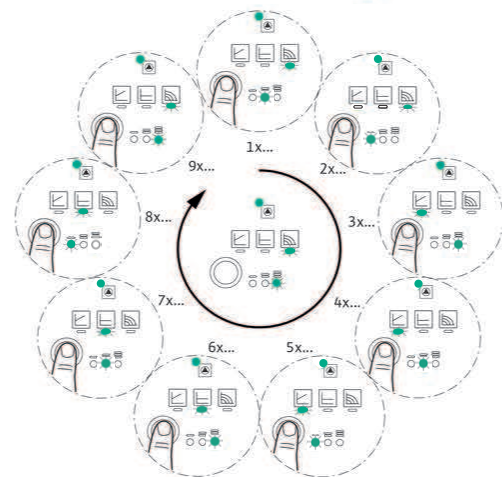

WILO-PARA SELF CONTROL / SMART FUNCTIONS

Air-venting mode

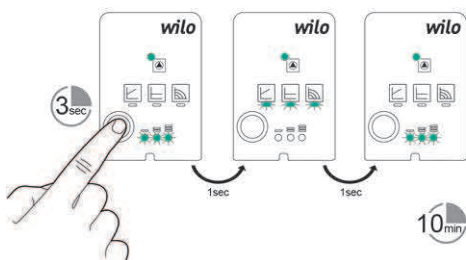

Manual restart

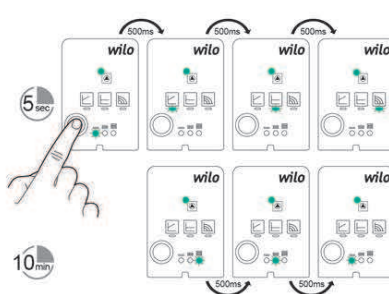

Lock & unlock

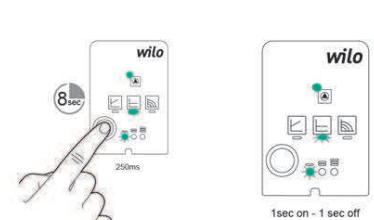



LK ARMATUR AB

www.lkarmatur.se

www.lkarmatur.com

LK ARMATUR DEUTSCHLAND GMBH

www.lkarmatur.de